

8 7 6 5 4 3 2 1

D
C
B
A

D
C
B
A

POSSIBLE CONTROL BOX LOCATION

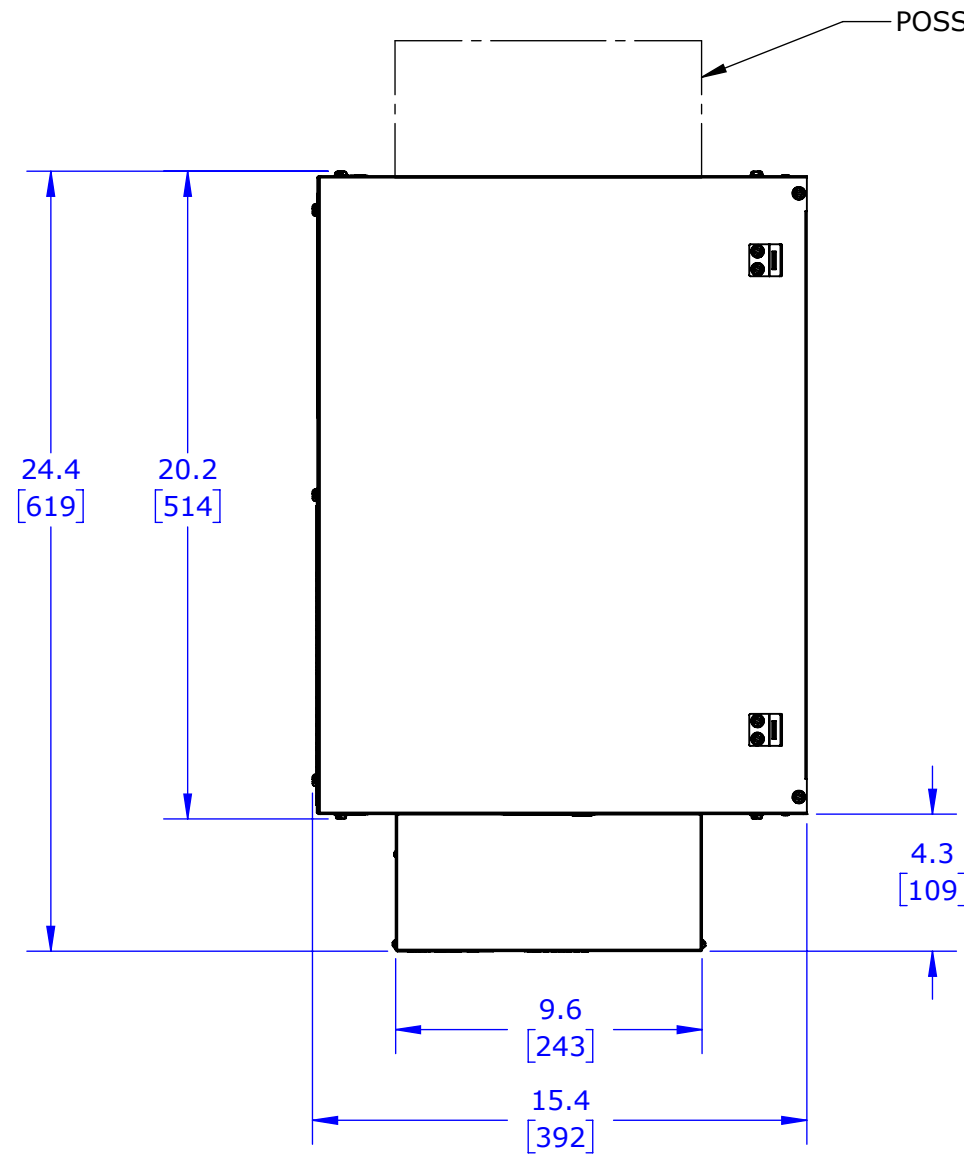

POSSIBLE CONTROL BOX LOCATION

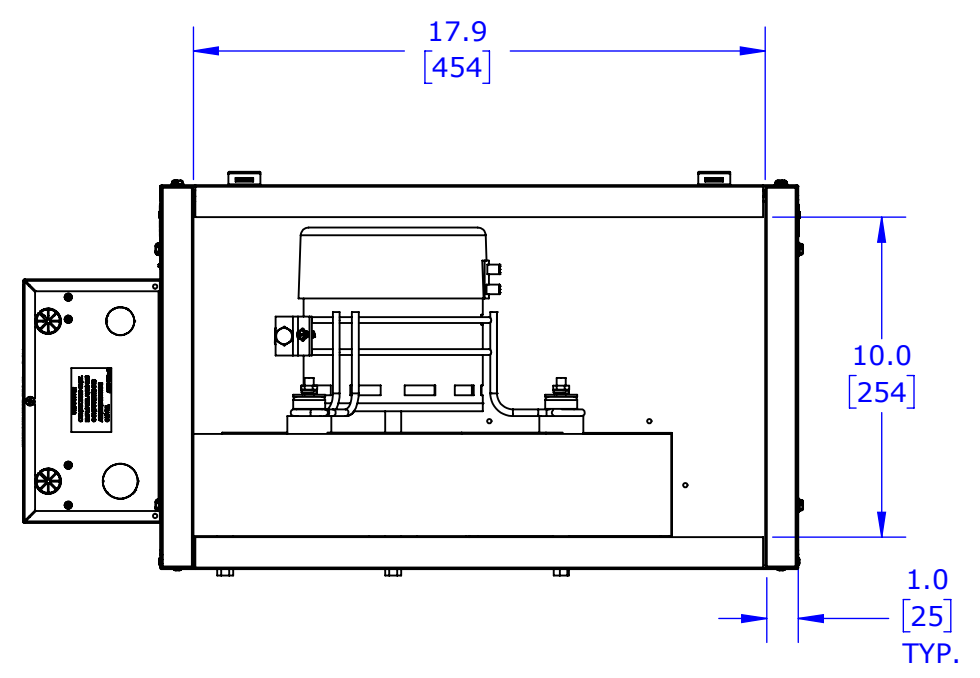
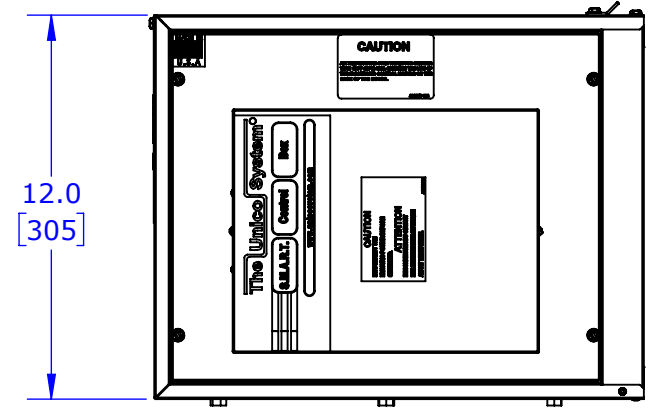
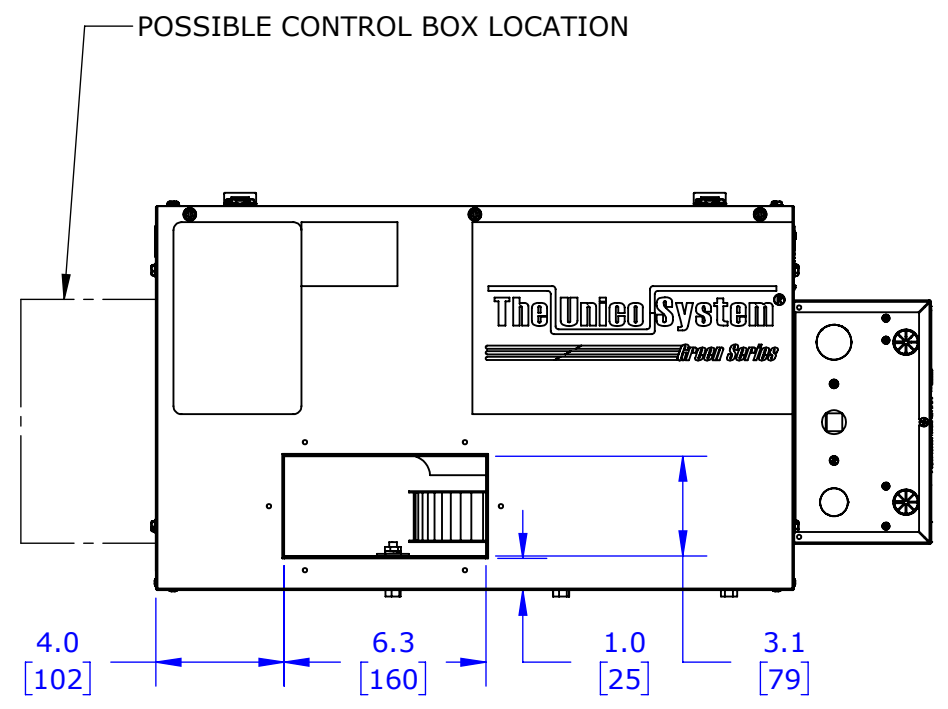

NOTE:
 1. ALL DIMENSIONS ARE IN INCHES [MM] UNLESS OTHERWISE SPECIFIED

DATE	DWG. NO.
12/3/2018	M1218BL1-EC3

8 7 6 5 4 3 2 1