

8 7 6 5 4 3 2 1

D
C
B
A

D
C
B
A

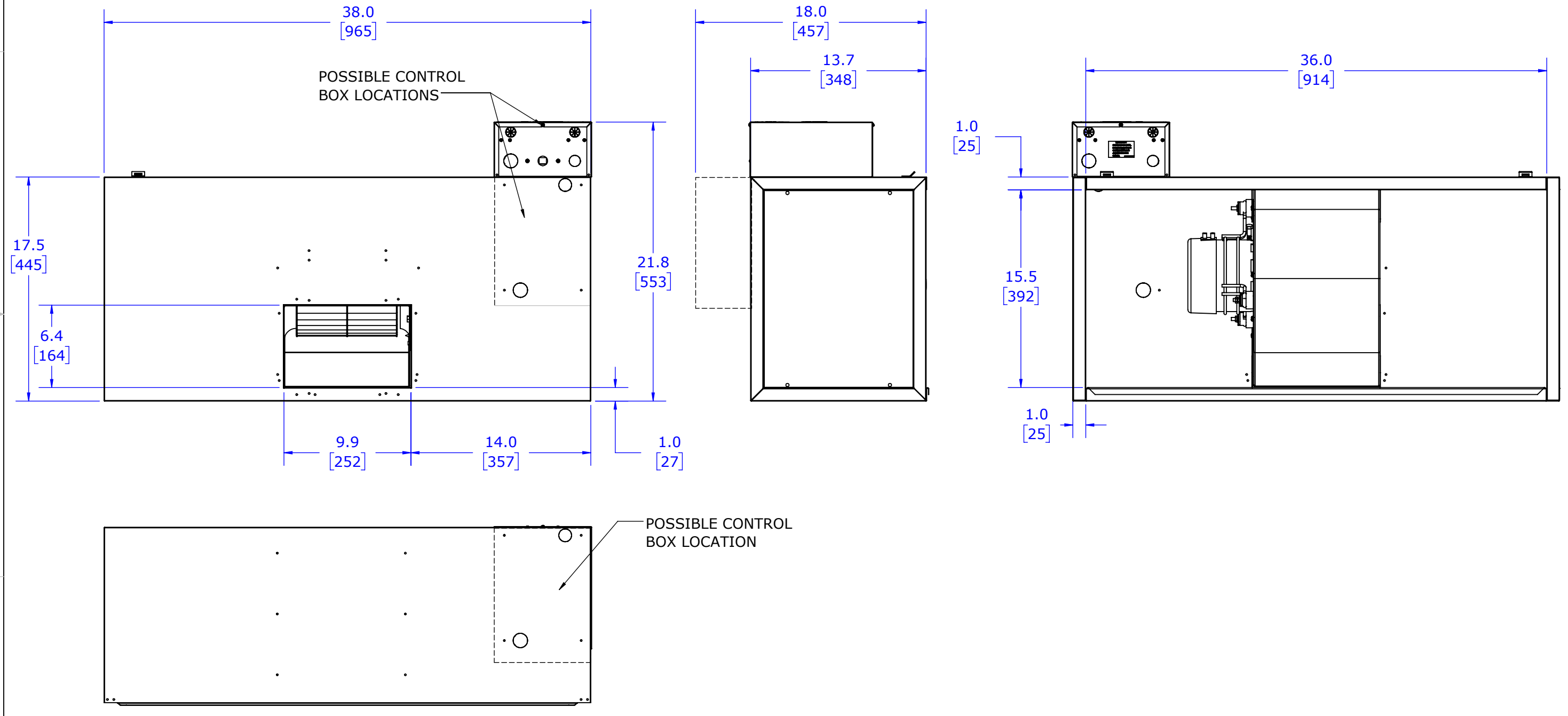

NOTES:
 1. ALL DIMENSIONS ARE IN INCHES [MM] UNLESS OTHERWISE SPECIFIED.

DATE	MODEL NO.
11/06/17	M4860BL1-EC2

8 7 6 5 4 3 2 1