

8 7 6 5 4 3 2 1

D
C
B
A

D
C
B
A

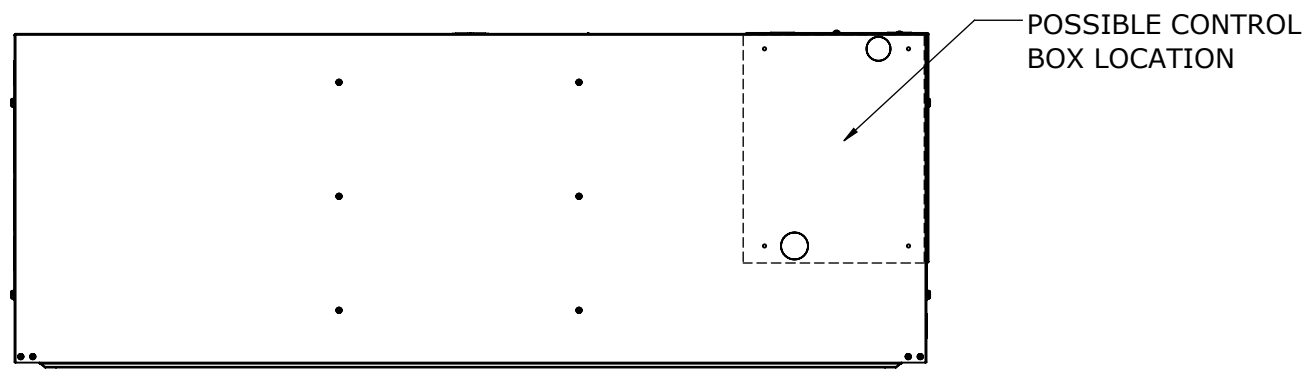
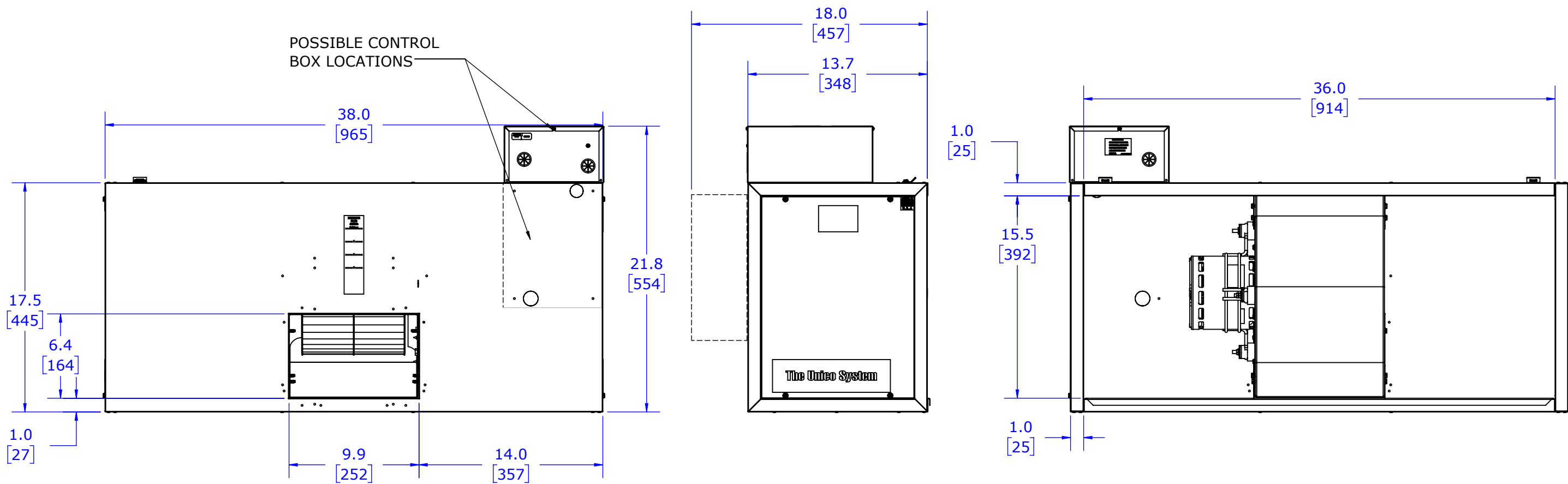

NOTES:
 1. ALL DIMENSIONS ARE IN INCHES [MM] UNLESS OTHERWISE SPECIFIED.

DATE	MODEL NO.
08/31/18	M4860BL2-ST2

8 7 6 5 4 3 2 1